

Measuring Instructions Double Hung 2 & 3 Lite Sliders Casement & Awning Windows

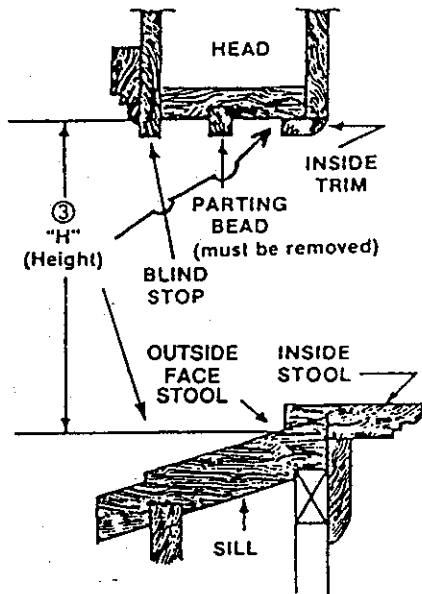

FIG. 2

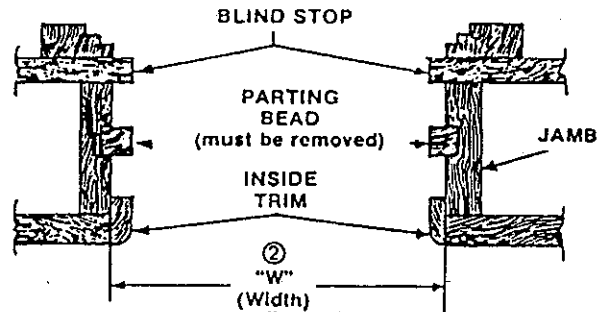

FIG. 1

WIDTH: Measure between jambs at three points: top, center, and bottom. Use smallest dimension. See Fig. 1. ② "W" (width).

HEIGHT: Measure from high point of sill (at outside face of stool) to top of window, in left and right sides. Use smallest dimension. See Fig. 2. ③ "H" (height).

NOTE: National Vinyl Products is only responsible for finished window size as ordered.

1. All replacement windows are manufactured any size to the 1/8" per size limitations.
2. Width: Measure between jambs at three points, top, center and bottom. Use smallest width dimension and deduct 1/4" to determine Tip to Tip or Manufactured Size. If you enter measurement size in opening size column we will follow the above mentioned deductions to get the manufactured size.

(Examples)

1. Width $28 \frac{3}{4}" - \frac{1}{4}" = 28 \frac{1}{2}"$
2. Width $28 \frac{11}{16}" - \frac{1}{16}" - \frac{1}{4}" = 28 \frac{3}{8}"$

This is the manufactured size of Width. In other words no manufacturing on the 1/16" of an inch.

3. Height: Measure from high point of sill, (at outside face of stool) to top of window, on left and right sides. Use smallest dimension and deduct 1/2" for Tip to Tip or Manufactured Size. If you enter measurement size in opening size column we will follow the above mentioned deductions to get the manufactured size.

(Examples)

1. Height $60 \frac{3}{4}" - \frac{1}{2}" = 60 \frac{1}{4}"$
2. Height $60 \frac{11}{16}" - \frac{1}{16}" - \frac{1}{2}" = 60 \frac{1}{8}"$

This is the manufactured size of Height. In other words no manufacturing on the 1/16" of an inch.

Casement Ordering Instructions: All casements are manufactured to the nearest 1/8" - 1/4" of opening size width and to the nearest 1/8" - 1/2" of opening size height. In other words no manufacturing to the 1/16" of an inch. All casement hinge locations are viewed from inside looking out.

DOUBLE-HUNG WINDOW REMOVAL PROCEDURES

Aluminum Removal

Aluminum fin windows are usually nailed to the studs in frame construction with siding, brick veneer, etc. applied over the fin on the outside. The interior usually has drywall return from the wall to the window frame. For removal, first remove the sash or glazing panels. Then pry up the aluminum sill in the middle, and cut the frame with a hack saw, using care not to damage the interior of the opening. Break each half of the sill away from the corners, and pry out the jambs starting from the bottom, cutting nails where practical. Then remove the header.

Steel Removal

Steel windows are generally found in homes of masonry construction, and consist of the window frame itself, plus an interior steel pan. Removing the pan can create major damage to interior walls. The window frame is usually screwed or bolted into a steel flange, which is nailed to the rough-in framing. To remove the window, first remove the screws or bolts (whose heads may be embedded in putty). Then pry the frame towards the center of the opening to remove it. It may be necessary to break glass and/or cut part of the frame in this process. You may also have to chisel off the heads of bolts or screws.

Wood Removal

The first step in removing a wood window is to remove the inside sash stop. Score first with a razor knife and use special care in removal, if the existing sash stop is to be reinstalled (see illustration). Older wood windows, counterbalanced the sash with a cord (rope) and pulley system in "pockets" in the wall beside the window frame. To remove, cut the cords and remove the lower sash. Carefully let the sash weights, attached to the cord, lower back down in the "pocket". Next, remove the parting stop (as shown), cut the cords and remove the upper sash (as shown). Remove (or pound in) pulley on both sides of opening. Later model wood windows, typically, have spring balances and aluminum or vinyl jamb liners. Aluminum jamb liners are usually nailed or stapled in place and vinyl liners are attached with clips or snapped into kerfs on the interior and exterior stops.

2 OPENING PREPARATION AFTER METAL REMOVAL

Whether the window removed was steel or aluminum framed, the opening must be flush to a depth equal to at least the thickness of the window's master frame. The wall's framing lumber may provide only part of the opening (with the steel pan or dry wall providing the rest). As long as the jamb is flush, move the stop, or add a stop, as far to the outside as possible, to allow sufficient exposed frame (and sill) to accommodate the 3/4" master frame of your replacement window unit. The stops must be straight and plumb to prevent bending the window frame. Once the outside stop is set in place, the window can be properly positioned in the opening. To make the opening maintenance-free, cover any exposed sill, trim, etc. with coil stock of pre-finished aluminum or vinyl. Apply flashing at the top of the opening.

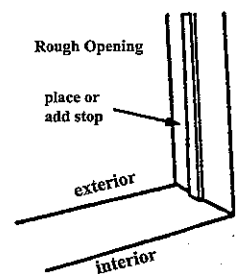
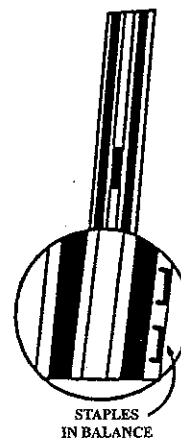
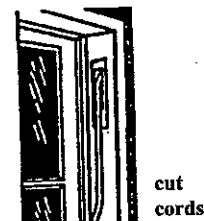
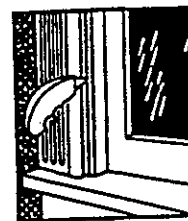
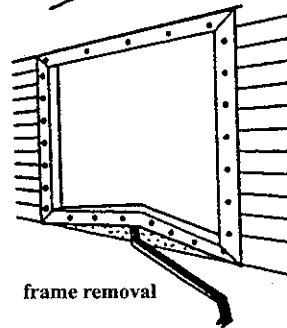
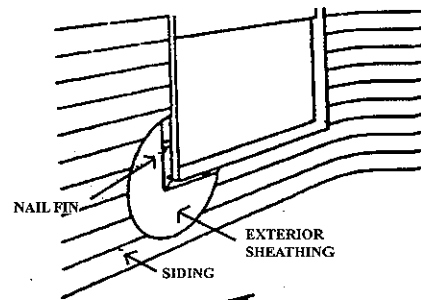

PRE-INSTALLATION PROCEDURES

- Measure the opening and the new window to ensure proper fit *before* you begin removal.
- Windows should be *minimum* of 1/2" smaller than opening to allow for movement/expansion of unit.
- Check for signs of decay, air leakage or water leakage that the replacement window alone will not solve. *Do not* install a replacement window without correcting these problems.
- Use a drop cloth to collect all debris from removal process.

INSTALLATION PROCEDURES

- On larger windows, it is best to remove both sash and screen from the master frame. You may install small windows with sash in place, but do not allow the master frame to spread (bow out) far enough for the sash pivot pin to come loose from the balance shoes. (Units with T-Bar systems prevent jamb spreading.)
- Place insulation in the head expander before placing it on top of the window, if used. Clean the opening of dirt and debris. On openings with sloped sills, caulk bottom of sill angle and place on the window opening sill approximately 1/8" in from outside stops on the opening sides - this allows window master frame to butt firmly against the exterior stop on the sides (jamb) and top (header), while overlapping the sill angle.
- Caulk the stops, sill and sill angle (if used).
- Insert the window frame into the opening and compress it tightly against the caulked stops and sill angle.
- Use a level and square to make sure the frame is level, square, and plumb, regardless of the squareness of the opening.
- Screw in, until just snug, all four installation screws, first the top two, then the bottom two, centering the frame from side to side and checking to be sure the frame remains square. (Temporarily shimming each corner as you tighten the screws helps to keep the frame centered and square.)
- Turn the jamb adjuster screws in the center of each side jamb until each jamb is straight and plumb and the opening across the center of the main frame measures the same as the opening at the top or bottom. Check again after driving screws to see that frame remains square.
- Install both sashes and then the screen. Check for proper operation, locking, and fit, and make adjustments as necessary.
- Stuff fiberglass or other insulation into the cavities between the master frame and the opening (do not overfill), and caulk the window to the opening.
- Reinstall the interior stop or mount new Chelsea #810 two-piece vinyl stop.

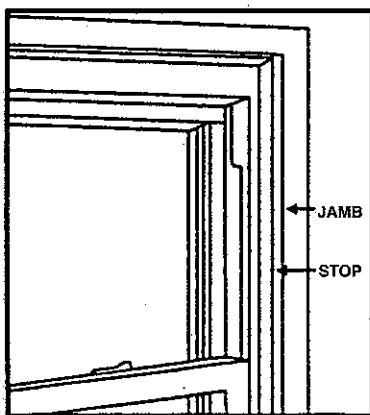
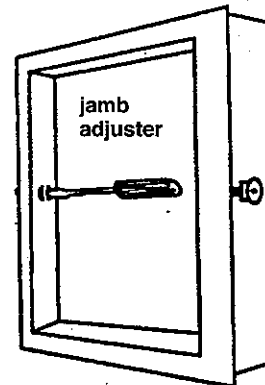
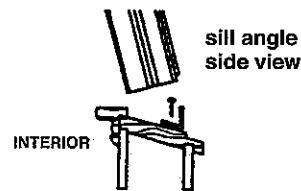
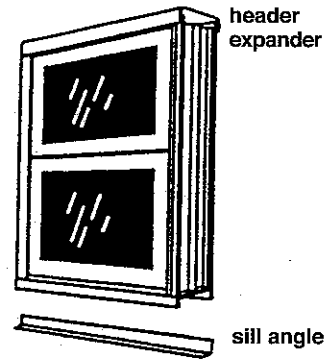

Handling Instructions

Care must be exercised in storage and handling. Store at a slight lean against a wall or a flat, level area, under cover. Allow sufficient spacing between products for ventilation. Do not store products under plastic, in direct sunlight. This will cause severe heat build-up and may create distortion and improper operation of unit. Store so that the full width of window head is supported. Do not drop product. Provide full support underneath frame when carrying and installing into framework. Do not lift windows by head only. Rough openings must provide ample clearance for window to be installed without force or racking the product. Rough opening dimensions should be a minimum of 1/2" wider and taller than window unit measurement.

Cleaning Instructions

Caution must be used to avoid damage to windows after installation. Vinyl may be cleaned with mild soap and water. Do not use any solvents, acids, or abrasives on the vinyl. To clean the glass, use a soft, clean, grit-free cloth and mild soap or detergent. Remove liquid by wiping dry or using a clean squeegee. Keep balances, weather stripping, hardware or window tracks clear of debris and dirt. Keep weep holes (if applicable) open and clear of obstructions.

CASEMENT WINDOW REMOVAL PROCEDURES

Aluminum Removal

Aluminum fin windows are usually nailed to the studs in frame construction with siding, brick veneer, etc. applied over the fin on the outside. The interior usually has drywall return from the wall to the window frame. For removal, first remove the sash or glazing panels. Then pry up the aluminum sill in the middle, and cut the frame with a hack saw, using care not to damage the interior of the opening. Break each half of the sill away from the corners, and pry out the jambs starting from the bottom, cutting nails where practical. Then remove the header.

Steel Removal

Steel windows are generally found in homes of masonry construction, and consist of the window frame itself, plus an interior steel pan. Removing the pan can create major damage to interior walls. The window frame is usually screwed or bolted into a steel flange, which is nailed to the rough-in framing. To remove the window, first remove the screws or bolts (whose heads may be embedded in putty). Then pry the frame towards the center of the opening to remove it. It may be necessary to break glass and/or cut part of the frame in this process. You may also have to chisel off the heads of bolts or screws.

Wood Removal

The first step in removing a wood window is to remove the inside sash bead stop. Score first with a razor knife and use special care in removal, if the existing sash stop is to be reinstalled (see illustration). **For wood casements:** Open the sash, remove screws from sash hardware, from track and from operator and remove these from opening. Remove any inside stops to create a level sill and frame. **For double hungs:** Cut the cords and remove the lower sash. Next, remove the parting stop, cut the cords (as shown) and remove the upper sash. Remove (or pound in) pulley on both sides of opening.

OPENING PREPARATION AFTER METAL REMOVAL

Whether the window removed was steel or aluminum framed, the opening must be flush to a depth equal to at least the thickness of the window's master frame. The wall's framing lumber may provide only part of the opening (with a steel pan or dry wall providing the rest). As long as the jamb is flush, move the stop, or add a stop, as far to the outside as possible, to allow sufficient exposed frame (and sill) to accommodate the 3/4" master frame of your replacement window unit. The stops must be straight and plumb to prevent bending the window frame. Once the outside stop is set in place, the window can be properly positioned in the opening. To make the opening maintenance-free, cover any exposed sill, trim, etc. with coil stock of pre-finished aluminum or vinyl. Apply flashing at the top of the opening. On old double-hung openings with sloped sills, caulk bottom of sill angle and place on window sill approximately 1/8" in from outside stops - this allows window master frame to butt firmly against the exterior stop on the sides (jamb) and top (header).

INSTALLATION INSTRUCTIONS

A single or twin unit may be installed through the installation holes pre-drilled (and capped) in the frames. All MULTIPLE casement units must be installed with screws through the frame and hinge as follows. Set unit in opening. Shim unit under side jambs (and at each mull) and at midpoint of each side jamb if necessary. Square the unit by using 2 1/2" installation screws through the pre-drilled holes in jambs (see illustration). Adjust the unit in the opening so that the edge of the glazing bead is parallel to inside edge of frame. Do NOT put in head installation screws until after ALL frame adjustments are completed.

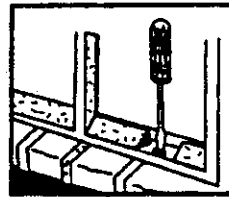
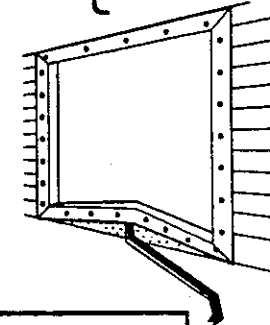
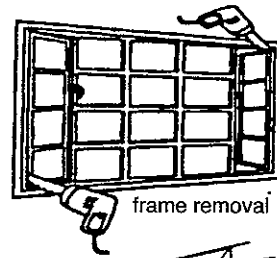

PRE-INSTALLATION PROCEDURES

- Measure the opening and the new window to ensure proper fit *before* you begin removal.
- Windows should be *minimum* of 1/2" smaller than opening to allow for movement/expansion of unit.
- Check for signs of decay, air leakage or water leakage that the replacement window alone will not solve. *Do not* install a replacement window without correcting these problems.
- Use a drop cloth to collect all debris from removal process.

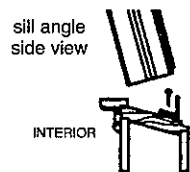
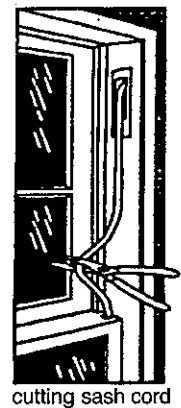
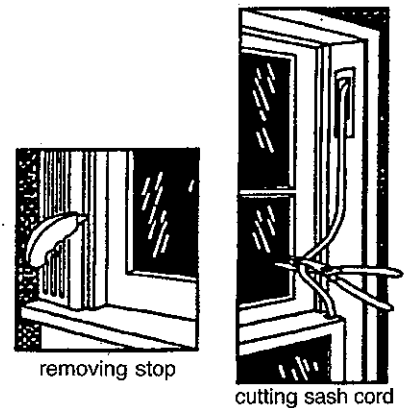

#8 x 2-1/2" PVC SHEET METAL
(INSTALLATION SCREW w/TTTT)
TWO-PIECE CAP

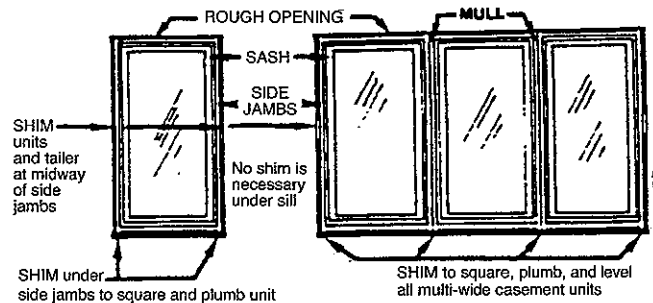
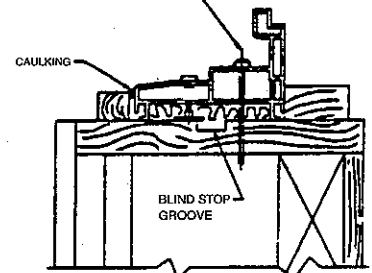

SECURING THE UNIT

Do not over tighten screws. Once all screws are in place, snap on cover of the screw cap on each screw. Make any necessary adjustments in jamb adjusters to make sure jambs are plumb. Again, check for squareness and place additional shims, if necessary.

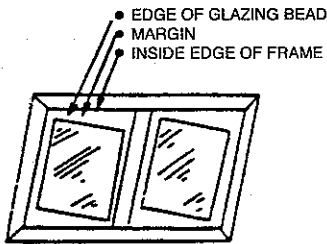

FIGURE 1 - WINDOW NOT SQUARE

Margins between frame and glazing bead are not parallel. Vents will not operate well.

PUT IN HEAD INSTALLATION SCREW(S)
AFTER FRAME IS ADJUSTED

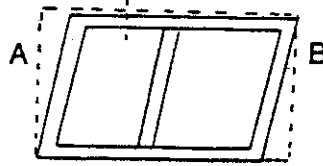

FIGURE 2 - TO ADJUST WINDOW

Back off Screw B and tighten Screw A until frame is square. Shim if necessary.

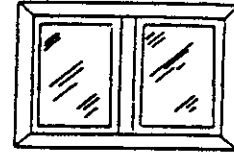
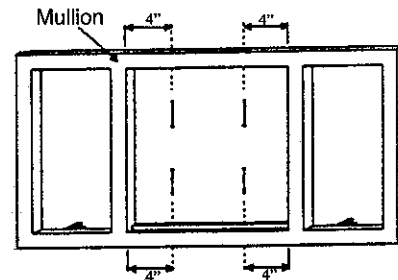
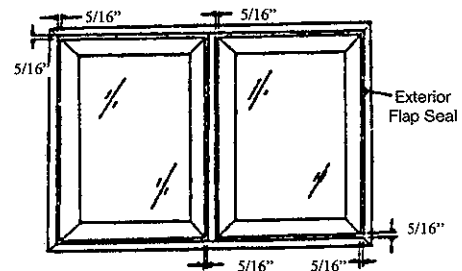

FIGURE 3 - WINDOW SQUARE

Margins between frame and glazing bead are parallel. Vents will operate correctly.

- A VISIBLE check for squareness of unit is to check the exterior flap seal. It should be a consistent $\frac{5}{16}$ " between frame and sash all the way around the window. Remove a hinge screw (on both top and bottom) on master frame closest to the lock and replace with a #8 x $2\frac{1}{2}$ " flathead #410 stainless steel sheet metal screw (see below left and center).
- Remove screw from casement ramps located on the sill of the main frame and replace with #8 x $2\frac{1}{2}$ " flathead #410 stainless steel sheet metal screw (see below right). This securely anchors the base of each unit.
- Any window over 4' x 4' or multiple casement units should have additional support screws added. Place the screws 4 inches from the mullion on the head and the sill near the top (see illustration). Drill $\frac{3}{16}$ " holes for #8 x $2\frac{1}{2}$ " flathead #410 stainless steel metal screws making sure the screws penetrate the sill plate and header. Use a small amount of caulk on the screw threads when securing sill screws as a precautionary measure for moisture prevention. These additional support screws aid in securely anchoring the base and header of each window. (For stationary windows, remove the sash and add the additional support screws, as stated.)



#8 x $2\frac{1}{2}$ flathead or pan
#410 stainless steel
sheet metal screw

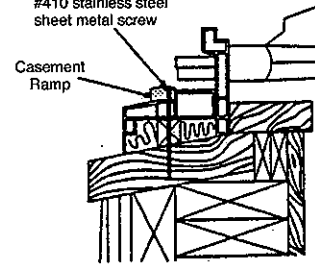
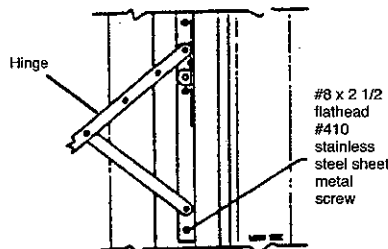
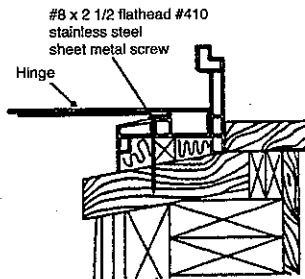

CHECK UNIT OPERATION

Operate the unit several times to ensure that the sash closes smoothly into the frame, that the locks operate correctly, and that there is a $\frac{5}{16}$ " distance between the sash and frame (covered by flap seal) around the entire perimeter of the sash.

FINISHING OFF INSTALLATION

Stuff insulation in opening between window frame and rough opening sides to block any air infiltration around the OUTSIDE of the unit. (Place insulation LOOSELY. Do not overfill.) Use drywall return, wood trim, or other appropriate finishing on the interior of unit and rim it to suit the exterior wall finishing as well. You may wish to use Chelsea two-piece vinyl stop #810.

BASEMENT HOPPER WINDOW REMOVAL PROCEDURES

Aluminum Removal

Aluminum fin windows are usually nailed to a wood buck in the block wall construction. For removal, first remove any inserts (sash, etc.). Then pry up the aluminum sill in the middle, and cut the frame with a hack saw, using care not to damage the interior of the opening. Break each half of the sill away from the corners, and pry out the jambs, starting from the bottom, cutting nails where practical. Then remove the header.

Steel Removal

Steel hoppers consist of the hopper frame itself, plus an interior steel pan. Removing the pan can create major complications, such as damage to interior walls. The window frame is usually screwed or bolted into a steel flange, which is nailed to the rough-in framing (wood buck in block wall). To remove the window, first remove the screws or bolts (whose heads may be embedded in putty). Then pry the frame towards the center of the opening to remove it. It may be necessary to break glass and/or cut part of the frame in this process. You may also have to chisel off the heads of bolts or screws.

Wood Removal

The first step in removing a wood window is to remove the inside sash stop. Score first with a razor knife and use special care in removal, if the existing sash stop is to be reinstalled (see illustration). On old wood hopper units, unlock sash and open. Remove screws, securing sash hardware in place and remove all old hardware and sash. Exterior stop (if applicable) may be left in place for installation (stop) of new unit.

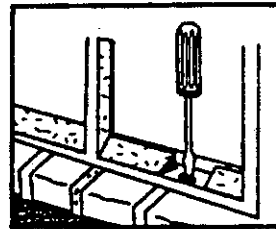
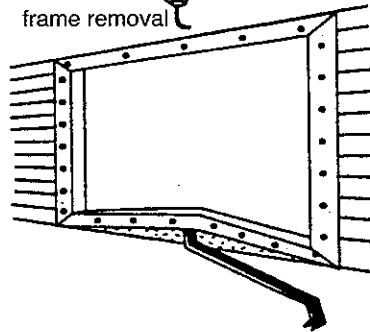
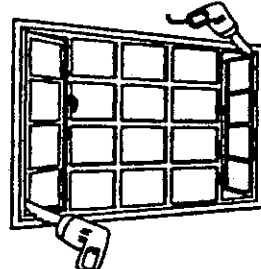

PRE-INSTALLATION PROCEDURES

- Measure the opening and the new window to ensure proper fit *before* you begin removal.
- Windows should be *minimum* of 1/2" smaller than opening to allow for movement/expansion of unit.
- Check for signs of decay, air leakage or water leakage that the replacement window alone will not solve. *Do not* install a replacement window without correcting these problems.
- Use a drop cloth to collect all debris from removal process.

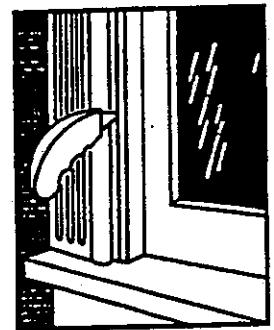

remove bead

OPENING PREPARATION AFTER METAL REMOVAL

Whether the window removed was steel or aluminum framed, the opening must be flush to a depth equal to at least the thickness of the window's master frame. The wall's framing lumber may provide only part of the opening (with a steel pan or dry wall providing the rest). As long as the jamb is flush, move the stop, or add a stop, as far to the outside as possible, to allow sufficient exposed frame (and sill) to accommodate the 3/4" master frame of your replacement window unit. The stops must be straight and plumb to prevent bending the window frame. Once the outside stop is set in place, the window can be properly positioned in the opening. To make the opening maintenance-free, cover any exposed sill, trim, etc. with coil stock of pre-finished aluminum or vinyl. Apply flashing at the top of the opening.

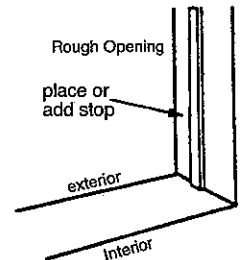

Installation Instruction

- Place window in opening (make sure Cam Lock Handle is to the INSIDE and to the TOP). Open sash allowing room to work. Snug window to wood plate using two #8 x 2" pan head or round head wood screws through PRE-DRILLED header holes.
- Locating screw-recess slot, drill two 1/8" pilot holes in each side jamb 2" from each inside corner. Drill deep so that the masonry wall is marked.
- Remove window from opening and drill into the masonry wall until you can fit anchor plugs in the holes.
- Return window to opening and snug window to top plate using same holes and screws as in step one. Make sure anchors line up with holes located and drilled in third step.
- Place screws through holes drilled in side jambs and into the anchor plugs and snug window to masonry wall making sure not to bow side jambs. If shims are required to maintain a straight and true jamb, they MUST be used.
- Check unit for operation and locking.
- Caulk exterior around main frame and wall.
- Finish inside as desired.

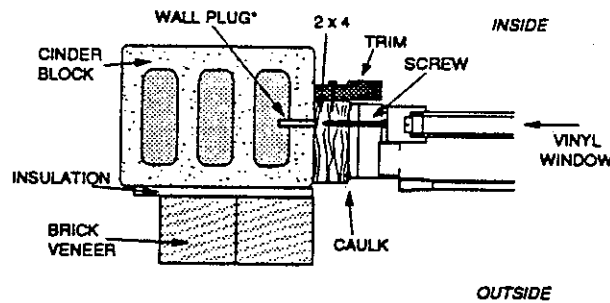
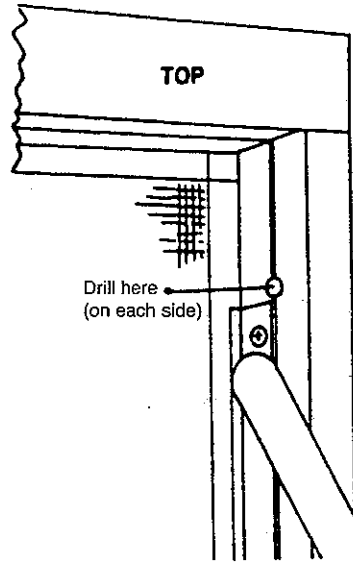

*Used in masonry openings without wood bucks.

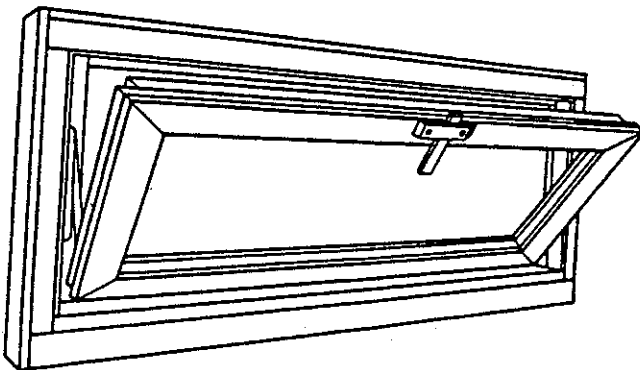

HANDLING INSTRUCTIONS

Care must be exercised in storage and handling. Store at a slight lean against a wall on a flat, level area, under cover. Allow sufficient spacing between products for ventilation. Do not store products under plastic, in direct sunlight. This will cause severe heat build-up and may create distortion and improper operation of unit. Store so that the full width of window head is supported. Do not drop product. Provide full support underneath frame when carrying and installing into frame work. Do not lift windows by head only. Rough openings must provide ample clearance for window to be installed without force or racking the product. Rough opening dimensions should be a minimum of 1/2" wider and taller than window unit measurement.

CLEANING INSTRUCTIONS

Caution must be used to avoid damage to windows after installation. Vinyl may be cleaned with mild soap and water. Do not use any solvents, acids, or abrasives on the vinyl. To clean the glass, use a soft, clean, grit-free cloth and mild soap or detergent. Be sure to remove liquid by wiping dry or using a clean squeegee. Keep window tracks clear of debris and dirt. Keep weep holes (if applicable) open and clear of obstructions.

NEW CONSTRUCTION INSTALLATION INSTRUCTIONS

1. PREPARATION

- a. Measure rough opening to ensure that it is no more than $\frac{1}{2}$ " larger than the window unit.
- b. Check the sill plate for level (adjust if necessary).
***The following sections, c & d, are for applications where feltwrap is to be used. If using a tape system continue on from section e.**
- c. Apply 8" to 12" of felt to the bottom face of the rough opening. Position the felt so that approximately 1" can lap over the sill. Run the felt 8" past each side of the opening. Staple the felt a minimum of 3" from the bottom to allow overlapping of the feltwrap.
- d. Wait to attach the felt to the jambs or head of the rough opening until the window has been set and nailed. Fold and staple the excess felt to the sill.
- e. Apply a continuous bead of caulk to the inside of the nailing fin. **The $\frac{3}{16}$ " to $\frac{1}{4}$ " bead should cover all the pre-punched nailing holes.**
- f. If the rough opening is larger than the window unit by $\frac{1}{2}$ " or more, apply the caulk to the sheathing making sure the bead is no more than $\frac{1}{4}$ " from the edge of the rough opening.
- g. Place $\frac{1}{4}$ " shims on the sill of the rough opening so the unit will hang in the opening when the shims are removed. This will allow for adjustment of the sill.

2. INSTALLATION - All nails must penetrate the stud at least 1" (adjust nail sizes as needed).

- a.) Install the window unit with the bottom sash in the upright or open position.
- b.) Nail one side of the meeting rail. Check for level (adjust shims if necessary). Then, nail the other side of the meeting rail.
- c.) Close lower sash so there is $\frac{1}{2}$ " equal space between the sash and dam leg (check reveal between the stiles and jambs and the lower sash and sill).
- d.) Open lower sash and nail the two bottom corners of the sill.
- e.) Open the upper sash to a position $\frac{1}{2}$ " below the head of the window (check reveals between the top rail and header and the stiles and jambs).
- f.) Open the sash and nail the two upper corners of the head.
- g.) Remove sill shims.
- h.) Close sash, check reveals again. (Check the space between the sash and frame to be sure it is equal from top to bottom and from side to side.)
- i.) Open sash and finishing nailing through every other pre-punched hole on the nailing fin.

- j. **Tape System:** Apply 3" tape or equivalent to cover the nailing fin of the jambs head and sill.
- k. **Feltwrap System:** Apply felt to the jambs of the window starting 6" above the head. Run a continuous strip of felt/tape along the jamb. The felt/tape must cover the nailing fin, extend 6" below the sill and overlap the paper at the sill. Run a piece of felt/tape across the head, covering the nailing fin, and overlap the felt on the jambs at least 6" on each side.

Note:

When using "J" channel, or wood trim, it is best to apply a $\frac{1}{4}$ " bead of caulk under the vinyl sill along its entire width. Once caulk is applied below the sill, raise the "J" channel or wood trim into place and secure normally.

3. INTERIOR PREPARATION

- a. Check sash for proper reveals and operation.
- b. Shim jambs, if necessary. Do not use foam insulation.
- c. Insulate around the window interior with Batt Fiber insulation.
- d.) To eliminate draughts, after finishing the interior (sheetrock, wood extension jambs, etc.) apply an even bead of caulk where trim meets window.

DO'S and DONT'S

DO'S

- Use undersill trim on all siding applications.
- Use beveled $\frac{5}{4}$ " trim in sill area on all wood trim installations.
- Caulk perimeter of nailing fin prior to installation.
- Caulk exterior finish (siding, masonry, wood trim) to window.

DONT'S

- Do not use expanding foam.
- Do not drill into the sill (i.e. burglar alarms).

IMPORTANT

Please Note:

Proper installation requires a level window sill, shimming may be necessary. Be sure to place shims where the side jambs and sill meet. Shimming other areas may cause the sill to bow.

* Do not use plastic wrap under the nail fin at the head area of the window. The window must be installed flush against the wall once the caulk is applied to the nail fin. Plastic wrap under the header nail fin may cause leaks above the window.

BAY-BOW & GARDEN WINDOWS

Ease of installation for all replacements ... Every National Vinyl Products Window is precision-built to your exact specifications.

PREPARATION

PREPARE THE OPENING: Remove interior trim, upper and lower window sash, jambs, sill, stool, apron and trim. Remove all to rough opening shown.

INSTALLATION

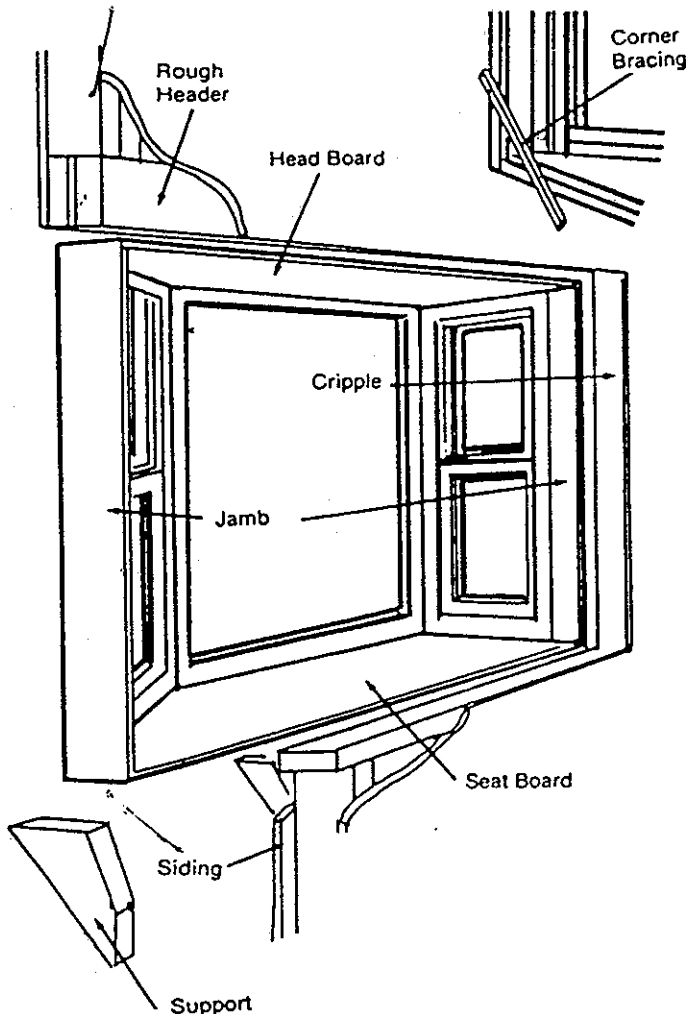
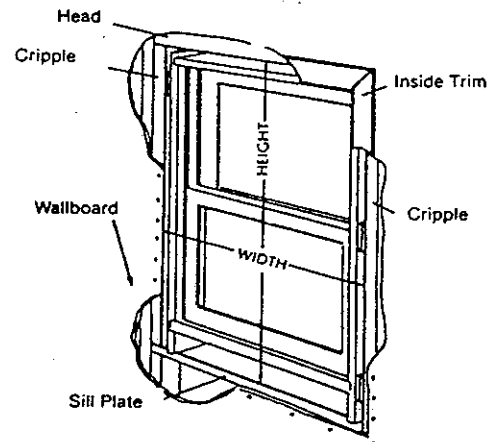

1. When possible, insert window unit from the exterior into rough opening. Interior edge of window unit must sit flush with interior wall.
2. Attach corner bracing on all four corners to secure window unit throughout installation.
3. Partially set #20 finish nails to secure head and sill prior to leveling.
4. Using cedar shim stock, level and plumb window unit in opening, making sure head and sill are level, jambs are plumb and blocked.
5. Check for squareness before final setting. Complete setting all #20 finish nails or 3/8" x 3" PN flat HD wood screws. Insulate around window unit as necessary. Remove corner Bracing.
6. Finish with interior moulding.

Requirements

A roof is **required** on all extended Bows and Bays. The roof should extend at least 2 inches beyond the window.

Also **required** are supports for the window. Knee Braces or the National Vinyl Products Cable System, which are standard on all Bays and Bows, are available.

If you should have any questions regarding installation, please consult with your qualified sales representative.

GARDEN WINDOW

INSTALLATION INSTRUCTIONS

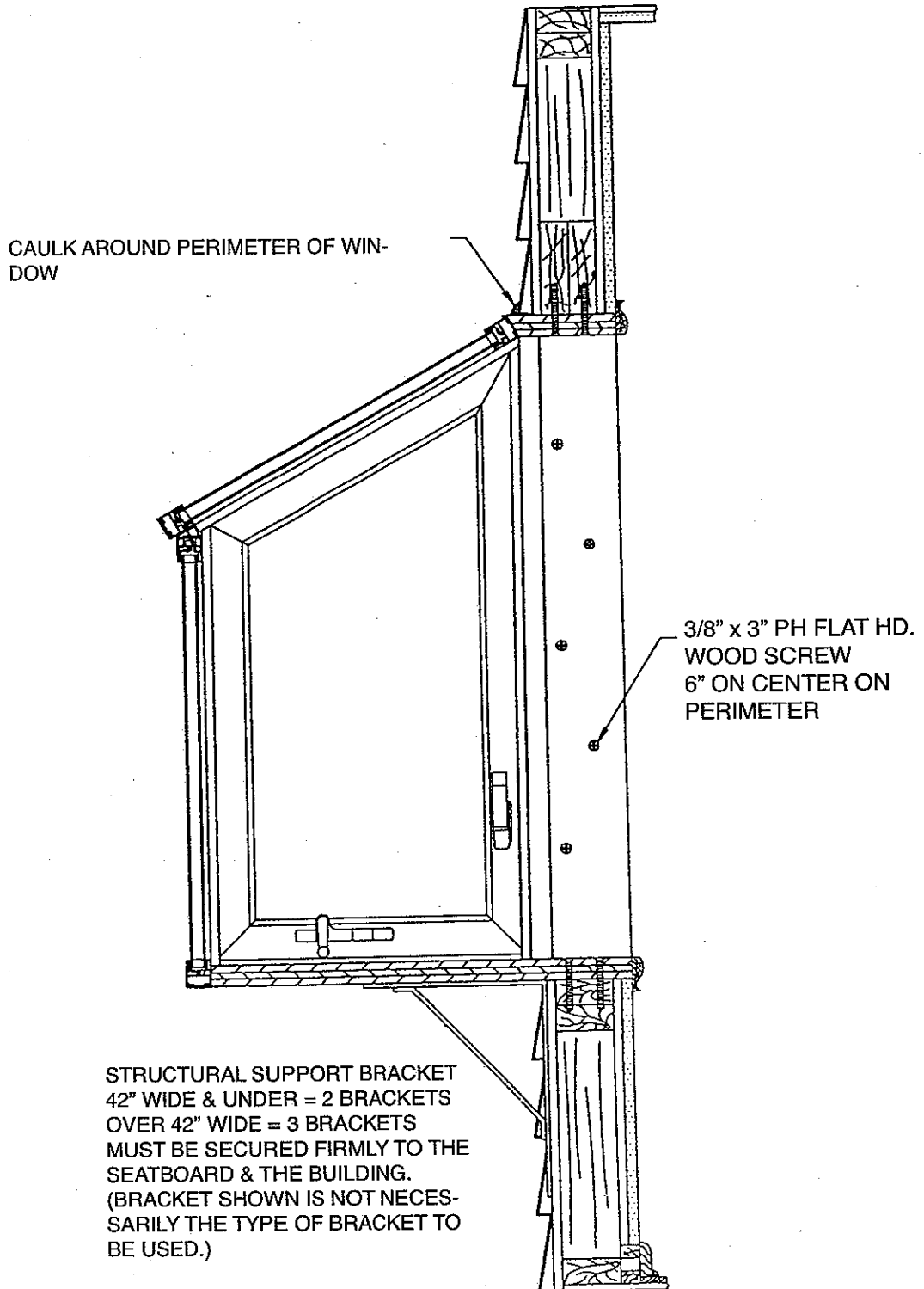

Installing Mullered Units

A mullered unit is the combining of 2 or 3 units into one opening.

Replacement windows can be mullered side by side (a picture window flanked by double hung on each side or two double hungs), or "stacked" on top of each other (a transom over a double hung or a picture window over an awning window).

The most common mullered units are side by side.

Horizontal Mulling:

1. Removal of old windows is the same as described for wood, steel, or aluminum.
2. Order windows to include a "Snap" mullion for each joint and a continuous head expander, and sill angle long enough to fit the entire width of mullered unit.
3. After opening is prepared for the replacement windows, remove all sashes of windows to be mullered.
4. Measure opening height approximately where units are to be mullered. Cut "Snap" mullion 1/4" less than opening height.
5. Measure opening width at top and cut continuous head expander 1/8" less than the width.
6. Measure opening width at bottom and cut continuous sill angle 1/8" less than the width.
- 7a. Northwind III - Remove sashes from operable units for easier mulling. Place all windows side by side. You will have a mullion strip for both interior and exterior (see figure A). Using a rubber mallet, insert mullions into accessory grooves, internally and externally.
- 7b. Prestige - Remove sashes from operable units for easier mulling. Apply "Snap" mullion to first window (See figure B). Align second window next to first and snap into place. This should be accomplished with regular hand pressure. If not, use clamps (take care not to damage the window). Proceed with same instructions if unit is a triple.
8. Install continuous head expander over top of windows and mullion.
9. Install sill angle if necessary.
10. Set windows into openings. Shimming the sides and aligning the windows carefully, try to keep the units tight to the mullion for maximum support.
11. Re-install and align sashes.
12. Complete installation with caulk, capping and trim as necessary.

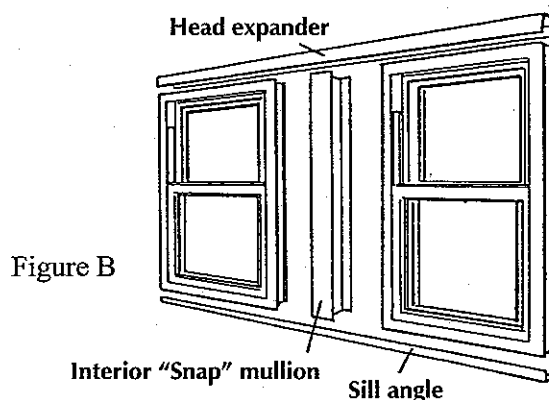
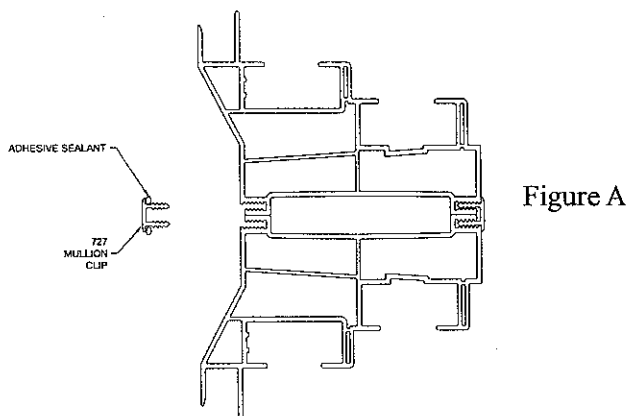

Vertical Mulling:

1. To mull vertically (stacked units), remove operating sash. Using the "Snap" mullion, cut it 1/8" less than opening width.
2. Place head expander on top window, and sill angle (if necessary) "below" lower window.
3. Caulk top of "Snap" mull before setting top window in "stacked" unit.
4. Use same instructions as in horizontal mull procedures sections 7a & 7b only on vertical application.
5. Carefully install mullered unit into opening. Re-install and align sash.
6. Complete installation with caulk, necessary capping and trim as necessary.

NOTE: All installation instructions are given as a guide only, to facilitate quality, finished work. Each installation, however, presents unique circumstances which may require modifying these installation techniques, or changing them to fit the needs of the job.

In every case, these instructions, along with a competent, experienced, conscientious, skilled workman should result in a quality job. National Vinyl Products warrants the performance of their window and door products, but cannot accept responsibility for their installation.

National Vinyl now has snap-in Mullions. Ask your sales representative for detailed information.